

# SBE®320 / SBX®350 Connectors

## - up to 350 Amps



SBX® and SBE® connectors can integrate up to 8 auxiliary power / signal contacts along with the two primary power circuits. Sequencing within auxiliary positions is possible using the 4 pin lengths available in the 1x4 auxiliary connector. The SBE® touch safety rating is equivalent to that of the SBS® connector line.

- **Silver Plated Wire Contacts up to 300 mcm (152 mm<sup>2</sup>)**  
*Allows low resistance UL rated currents up to 350 amps per pole*
- **Up to 8 Last-mate / First-break Auxiliaries**  
*Enables intelligent power switching, CAN and interlock loop circuitry, as well as power up to 20 amps per pole*
- **Durable Housings and Contacts**  
*Like all Multipole connectors, the silver plated power contacts are rated up to 10,000 mating cycles*

## | SBE®320 / SBX®350 ORDERING INFORMATION |

### SBE®320 / SBX®350 Housings

The largest size of SBE®, X, O style housing. SBE® housings are molded from a chemical resistant PBT. SBX® housings are molded from PC. SBE®320 and SBX®350 housings of the same Voltage Color Code cannot be mated. SBX®350 housings do not meet EN1175-1 requirements for industrial trucks.

| Description | - SBE®320 Part Numbers - |       | - SBX®350 Part Numbers - |      |    |
|-------------|--------------------------|-------|--------------------------|------|----|
|             | Minimum Quantity .....   | 100   | 25                       | 100  | 25 |
| Yellow      | 2-8171G6                 | E6362 | 2-7249G6                 | 6362 |    |
| Orange      | 2-8171G7                 | E6339 | 2-7249G7                 | 6339 |    |
| Red         | 2-8171G3                 | E6352 | 2-7249G3                 | 6352 |    |
| Gray        | 2-8171G1                 | E6350 | 2-7249G1                 | 6350 |    |
| Blue        | 2-8171G2                 | E6351 | 2-7249G2                 | 6351 |    |
| Green       | 2-8171G4                 | E6353 | 2-7249G4                 | 6353 |    |
| Black       | 2-8171G5                 | E6361 | 2-7249G5                 | 6361 |    |
| Brown       | 2-8171G8                 | E6336 | N/A                      | N/A  |    |
| Purple      | 2-8171G9                 | E6349 | N/A                      | N/A  |    |

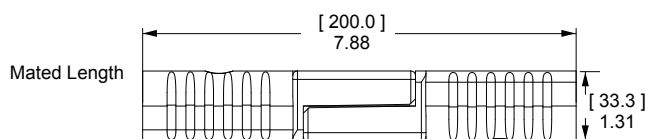
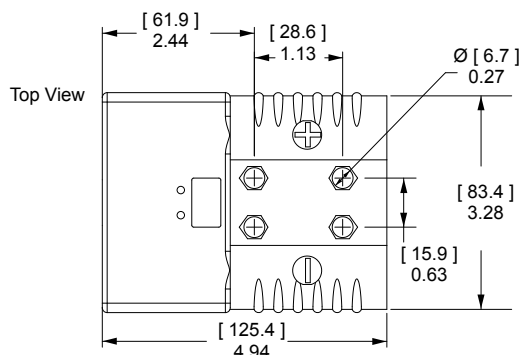

### SBE®320 / SBX®350 Silver Plated Primary Power Wire Contacts

Silver plated contacts offer superior electrical performance and durability up to 10,000 mating cycles. See reducing bushings in accessory section for smaller wires.

| AWG     | mm <sup>2</sup> | - Loose Piece Part Numbers - |     | Dimensions |      |        |      |        |      |        |      |       |
|---------|-----------------|------------------------------|-----|------------|------|--------|------|--------|------|--------|------|-------|
|         |                 |                              |     | - A -      |      | - B -  |      | - C -  |      | - D -  |      |       |
|         |                 |                              |     | inches     | mm   | inches | mm   | inches | mm   | inches | mm   |       |
| 300 mcm | 150             | 200                          | 150 | 50         | 3.03 | 76.96  | 0.88 | 22.20  | 0.75 | 19.05  | 1.25 | 31.80 |
| 4/0     | 120             | 6356-BK                      | -   | 6356 *     | 3.10 | 78.74  | 0.75 | 19.05  | 0.64 | 16.26  | 1.25 | 31.80 |
| 3/0     | 95              | 6355-BK                      | -   | 6355 *     | 3.10 | 78.74  | 0.70 | 17.78  | 0.58 | 14.73  | 1.25 | 31.80 |
| 2/0     | 70              | 6354-BK                      | -   | 6354 *     | 3.10 | 78.74  | 0.64 | 16.26  | 0.49 | 12.45  | 1.25 | 31.80 |
| 2       | 35              | 6394-BK                      | -   | 6394 *     | 3.10 | 78.74  | 0.51 | 12.95  | 0.38 | 9.50   | 1.25 | 31.80 |

\* Sold as pairs. 2 parts shipped for every 1 part ordered.

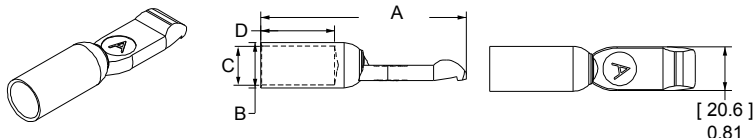

© 2018 Anderson Power Products, Inc. All rights reserved. APP®, Anderson Power Products®, A®, SBE®, SBO®, SBX®, PowerMod®, Powerpole® and the APP Logo are registered trademarks of Anderson Power Products, Inc.

## SBE®320 DIN Standard Silver Plated Primary Power Wire Contacts

Crimp barrel O.D. are compliant with DIN standard tooling. Will also fit into SBX®350 housings. Not recommended for cross mating with above typical contacts for SBE® & SBX®.

| AWG                  | mm <sup>2</sup> | Loose Piece  |          | Dimensions |       |        |       |        |       |        |       |
|----------------------|-----------------|--------------|----------|------------|-------|--------|-------|--------|-------|--------|-------|
|                      |                 | Part Numbers |          | - A -      |       | - B -  |       | - C -  |       | - D -  |       |
| Minimum Quantity ... |                 | 200          | 50       | inches     | mm    | inches | mm    | inches | mm    | inches | mm    |
| 3/0                  | 95              | 1341G3-BK    | 1341G3 * | 2.89       | 73.41 | 0.78   | 19.81 | 0.59   | 14.99 | 0.94   | 23.88 |
| 2/0                  | 70              | 1341G2-BK    | 1341G2 * | 2.74       | 69.60 | 0.68   | 17.27 | 0.51   | 12.95 | 0.79   | 20.07 |
| 1/0                  | 50              | 1341G1-BK    | 1341G1 * | 2.65       | 67.31 | 0.57   | 14.48 | 0.43   | 10.92 | 0.79   | 20.07 |

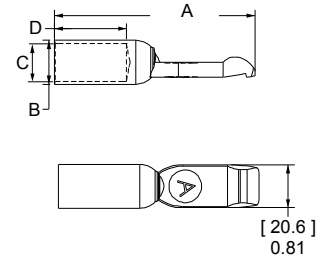

\* Sold as pairs. 2 parts shipped for every 1 part ordered.

## | SBE®320 / SBX®350 CONNECTOR SPECIFICATIONS |

| Electrical  |                |                  |  |
|---|----------------|------------------|--|
| <b>Current Rating Amperes <sup>1</sup></b>                  | <b>SBX350</b>  | <b>SBE320</b>    |  |
| Primary Power (300 mcm)                                     | 350            | 320              |  |
| Powerpole® Auxiliary (12 AWG)                               | 20             | 20               |  |
| 1x4 Auxiliary (12 AWG)                                      | 20             | 20               |  |
| PPMX Auxiliary (20 AWG)                                     | 7 UL           | 5 CSA            |  |
| <b>Voltage Rating AC/DC</b>                                 | <b>UL 1977</b> | <b>EN1175-1</b>  |  |
| Primary Power   | 600            | 150 <sup>4</sup> |  |
| Powerpole® Auxiliary  | 600            | 150 <sup>4</sup> |  |
| 1x4 Auxiliary   | 200            |                  |  |
| PPMX Auxiliary  | 300            |                  |  |
| <b>Dielectric Withstanding Voltage Primary Power</b>        |                |                  |  |
| Volts AC  | 2,200          |                  |  |
| <b>Avg. Mated Contact Resistance Milliohms <sup>1</sup></b> |                |                  |  |
| 2 1/2" of 300mcm wire                                       | 0.050          |                  |  |

| Materials                                      |                                 |
|--|---------------------------------|
| <b>Housing</b>                                 |                                 |
| SBX® and Powerpole® Plastic Resin              | Polycarbonate                   |
| SBE®, PPMX Auxiliary and 1x4 Auxiliary Housing | Polycarbonate / PBT blend       |
| Contact Retention Spring                       | Stainless Steel                 |
| <b>Housing Flammability Rating</b>             |                                 |
| UL94   | V-0                             |
| Glow Wire - SBE320 Only                        | 960°C (GWFI) / 850°C (GWIT)     |
| <b>Power &amp; Powerpole® Contact</b>          | Silver Plated Copper Alloy      |
| <b>1x4 Auxiliary Contacts</b>                  |                                 |
| Pin  | Copper alloy, Au over Ni        |
| Socket   | BeCu, Au over Ni                |
| Socket Body                                    | Copper alloy, Sn bright over Ni |
| Retention Clip                                 | Stainless Steel                 |
| <b>PPMX Contacts</b>                           | Gold Plated Copper Alloy        |
| <b>Contact Termination Methods</b>             |                                 |
| Crimp <sup>3</sup>                             |                                 |
| Hand Solder                                    |                                 |

| Mechanical                                   |                    |                       |
|--|--------------------|-----------------------|
| <b>Wire Size Range</b>                       | <b>AWG</b>         | <b>mm<sup>2</sup></b> |
| Power Contacts                               | 1/0 to 300 mcm     | 53.5 to 152           |
| Auxiliary Contacts                           | 24 to 10           | 0.25 to 5.3           |
| <b>Max. Wire Insulation Diameter</b>         | <b>in.</b>         | <b>mm</b>             |
| Power Contacts                               | 0.440              | 11.200                |
| Powerpole® Auxiliary                         | 0.175              | 4.450                 |
| 1x4 Auxiliary                                | 0.140              | 3.600                 |
| <b>Operating Temperature <sup>2</sup></b>    | <b>°F</b>          | <b>°C</b>             |
| SBX Housing and SBX With Auxiliary           | -4° to 221°        | -20° to 105°          |
| SBE Housing                                  | -40° to 221°       | -40° to 105°          |
| SBE Housing With Powerpole Auxiliary         | -4° to 221°        | -20° to 105°          |
| SBE Housing With 1x4 and PPMX Auxiliary      | -40° to 221°       | -40° to 105°          |
| <b>Mating Cycles No Load by Plating</b>      | <b>Silver (Ag)</b> | <b>Gold (Au)</b>      |
| Power Contacts                               | 10,000             |                       |
| Powerpole® Auxiliary                         | 10,000             |                       |
| 1x4 Auxiliary                                |                    | 10,000                |
| PPMX Auxiliary                               |                    | 5,000                 |
| <b>Avg. Mating / Unmating Force</b>          | <b>Lbf.</b>        | <b>N</b>              |
| Main Connector Housing                       | 45                 | 200                   |
| Per Powerpole® Connector                     | 5.00               | 22.00                 |
| Per Contact in 1x4 Auxiliary                 | 0.70               | 3.00                  |
| Per PPMX Housing                             | 4.50               | 20.00                 |
| <b>Min. Contact / Spring Retention Force</b> | <b>Lbf.</b>        | <b>N</b>              |
| Power Standard Housing                       | 150                | 667.2                 |
| Powerpole® Housing                           | 25                 | 111                   |
| 1x4 Auxiliary Housing                        | 10                 | 44.5                  |
| PPMX Housing                                 | 12                 | 53                    |

NOTE 1: See IEC 60664-1 for working voltage.

NOTE 2: Amp ratings are stated per position and based on all positions being fully loaded.

<sup>1</sup> Based on: 105°C rated or better cable of the largest size, Properly calibrated APP recommended tooling, and a 25°C ambient temperature. UL rating not to exceed the maximum operating temperature. CSA rating below a 30°C temperature rise.

<sup>2</sup> Limited by the thermal properties of the connector plastic housing.

<sup>3</sup> Use APP recommended tooling only. Alternate tools may adversely affect the performance of our connectors along with UL and CSA recognition.

<sup>4</sup> Voltage capability of SBE® housings is identical to SBX®, but derated to meet EN1175-1 requirements.



# IEC INFORMATION |

| Connector Series | Configurations | Creepage/Clearance per IEC 60950-1 | Material Group |
|------------------|----------------|------------------------------------|----------------|
| SBE®320          | Unmated        | 5.6 mm                             | IIla           |
|                  | Mated          | 24.7 mm                            |                |

| Attributes                            | SBE320                                    |
|---------------------------------------|---|
| AMP Rating AC/DC                      | 320 Amp                                   |
| Voltage Rating AC/DC (Steady State)   | 600 V AC/DC ( Operational)                |
| Breaking Capacity -AMP Rating /Cycles | 275 Amp / 10 Cycles                       |
| Voltage Rating (Breaking Capacity)    | 220 VDC                                   |
| FINGER Safety - Mated/Unmated         | IEC 60529 - IP20                          |
| Wire Size tested                      | 120 mm <sup>2</sup>                       |
| Contact Series Tested                 | 6356                                      |
| Climatic Testing (Cold,Heat & MFG)    | IEC 60512 Test -11j, 11i & 11g,           |
| Cycle Life                            | IEC 60512 Test 9a - 5000 Cycles           |
| Mechanical Strenght Impact            | IEC 60512-5 @ 29.5 Inches dropped 8 times |
| Temperature Range                     | -20 °C to 105 °C<br>-4 °F to 221 °F       |

| Protection                                 |      |
|--|------|
| <b>Touch Safety Main Connector Housing</b> |      |
| IEC 60950 SBE®320 Only                     | Pass |
| IEC 60529 SBE®320 & SBX®350                | IP20 |

NOTE 3: Refer to the Constructional Data form for additional information on our website., [www.andersonpower.com](http://www.andersonpower.com)



## SBE® 320 / SBX® 350 CONNECTOR TEMPERATURE CHARTS|

Temperature rise charts are based on a 25°C ambient temperature.

For Temperature Rise Above 60°C, Consult the Extended Temperature Rise Charts in the Appropriate Product Section on the Website.

Current - Temperature Derating per IEC 60512-5-2 Test 5B

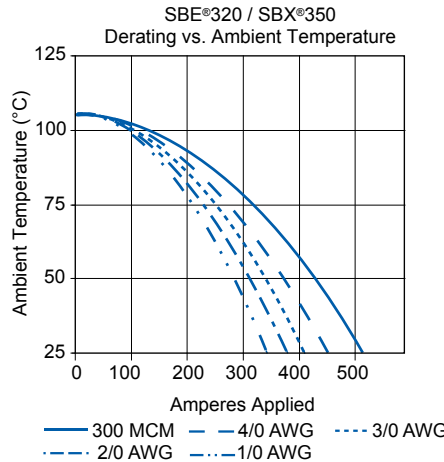
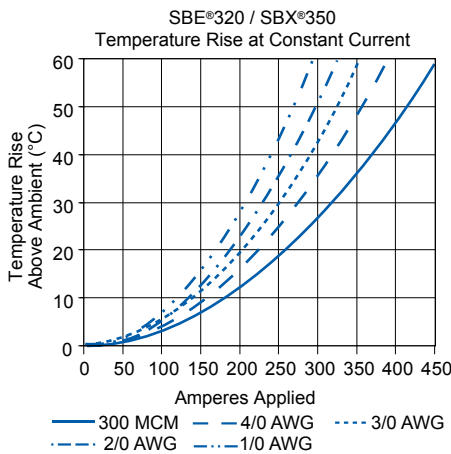

## SBE® 320 / SBX® 350 ACCESSORIES |

### Cable Clamps

Durable metal clamps adapt to a wide range of cable sizes. Cable clamp kit includes Clamp Top and Bottom as well as the Hardware Bag.

| Description      | Cable Size            |                   | - Part Number - |
|------------------|-----------------------|-------------------|-----------------|
|                  | Min / Max Inches O.D. | Min / Max mm O.D. |                 |
| Minimum Quantity |                       |                   | 25              |
| Cable Clamp Kit  | 0.85 to 0.67          | 21.6 to 17.1      | 911G2           |

The given wire O.D. information is an estimate. Cable clamps should be evaluated for performance with the actual wire to be used.

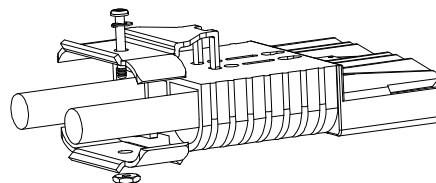

## Handles

Handles are made out of durable PC plastic. Hardware to attach to connector body included in kits.

| Description           | ----- Part Numbers ----- |        |
|-----------------------|--------------------------|--------|
| Minimum Quantity .... | 100                      | 25 ... |
| Gray Handle Kit       | 995G2-APP                | 995G2  |
| Red Handle Kit        | 995G4-APP                | 995G4  |
| Handle Only, Gray     | 3-5074P1                 | -      |
| Handle Only, Red      | 3-5074P3                 | -      |
| Handle Only, Black    | 3-5074P5                 | -      |
| Hardware Bag          | -                        | 106G7  |

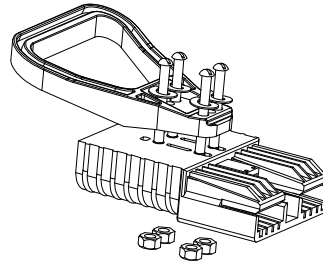

## Powerpole® Auxiliary

Powerpole® auxiliary connectors are rated up to 30 amps 600 volts and can be used for auxiliary power, control or sensing. The auxiliary kit includes (1) each black and red Standard Powerpole® housing, (2) contacts, (2) zip cable straps, and (2) retaining pins. (1) Retaining clip can be substituted for (2) retaining pins.

| Description                                 | ----- Part Numbers ----- |        |
|---|--------------------------|--------|
| Minimum Quantity .....                      | 200                      | 25 ... |
| Powerpole® Auxiliary Kit #16 to #12 Contact | -                        | 6305G1 |
| Powerpole® Auxiliary Kit #20 to #16 Contact | -                        | 6310G1 |
| Black Powerpole® Housing                    | 1327G6                   | -      |
| Red Powerpole® Housing                      | 1327                     | -      |
| #16 to #12 Contact                          | 1331                     | -      |
| #20 to #16 Contact                          | 1332                     | -      |

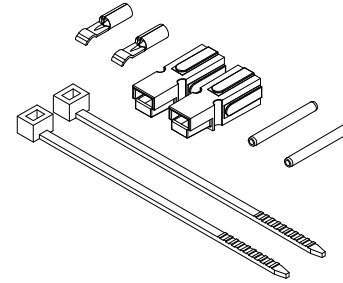

## 1x4 Auxiliary Connector

The unique 1x4 auxiliary connector allows up to 4 auxiliary circuits up to 20 amps 150 volts each in SBE®, SBO®, & SBX® housings. The genderless design holds two each of the gold plated pin & socket contacts. This innovation allows the very durable and cost effective design of SBE®, O,X connectors to substitute for DIN 43589-1 applications where 4 auxiliary contacts are required. Multiple pin lengths allow the further benefit of sequencing between circuits. (2) Retaining pins or (1) Retaining clip is required to hold the auxiliary housing in place. Auxiliary Kits include (1) Auxiliary Housing, (2) Standard Length Pin Contacts, (2) Socket Contacts, (2) Retaining Pins and (1) Retaining Clip.

| Description            | AWG                      | mm <sup>2</sup> | ----- Part Numbers ----- |       |        |
|------------------------|--------------------------|-----------------|--------------------------|-------|--------|
| Minimum Quantity ..... |                          |                 | 1,000                    | 250   | 25 ... |
| 1x4 Auxiliary Kit      | 12                       | 4               | -                        | -     | 440G3  |
| 1x4 Auxiliary Kit      | 16 to 14                 | 1.5 to 2.5      | -                        | -     | 440G1  |
| 1x4 Auxiliary Kit      | 20 to 16                 | 0.75 to 1.5     | -                        | -     | 440G2  |
| 1x4 Auxiliary Housing  | Contacts Sold Separately |                 | 3-5956P1                 | 444G1 | -      |

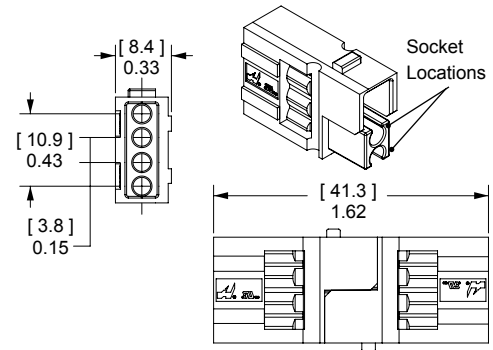

## Pin Contacts for 1x4 Auxiliary Connector

Gold plated contacts are available in 4 lengths to allow sequencing of circuits.

| Description            | AWG      | mm <sup>2</sup> | ----- Part Numbers ----- |                 |
|------------------------|----------|-----------------|--------------------------|-----------------|
| Minimum Quantity ..... |          |                 | 500                      | 50 .....        |
| Standard Length 7.7mm  | 12       | 2.5             | PM16P12S30               | PM16P12S30-50   |
|                        | 16 to 14 | 1.0 to 1.5      | PM16P1416S30             | PM16P1416S30-50 |
|                        | 20 to 16 | 0.75 to 1.0     | PM16P1620S30             | PM16P1620S30-50 |
|                        | 24 to 20 | 0.50 to 0.75    | PM16P2024S30             | PM16P2024S30-50 |
| Pre-Mate 9.3mm         | 12       | 2.5             | PM16P12A30               | PM16P12A30-50   |
|                        | 16 to 14 | 1.0 to 1.5      | PM16P1416A30             | PM16P1416A30-50 |
|                        | 20 to 16 | 0.75 to 1.0     | PM16P1620A30             | PM16P1620A30-50 |
|                        | 24 to 20 | 0.50 to 0.75    | PM16P2024A30             | PM16P2024A30-50 |
| Post-Mate 6.4mm        | 12       | 2.5             | PM16P12C30               | PM16P12C30-50   |
|                        | 16 to 14 | 1.0 to 1.5      | PM16P1416C30             | PM16P1416C30-50 |
|                        | 20 to 16 | 0.75 to 1.0     | PM16P1620C30             | PM16P1620C30-50 |
|                        | 24 to 20 | 0.50 to 0.75    | PM16P2024C30             | PM16P2024C30-50 |

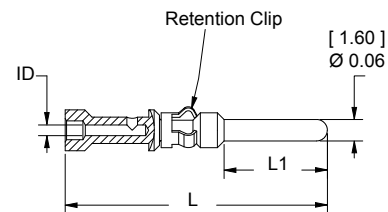

| Auxiliary Pin Contact Lengths | - L - |      | - L1 - |     |
|-------------------------------|-------|------|--------|-----|
|                               | in.   | mm   | in.    | mm  |
| Standard Length 7.7mm         | 0.77  | 19.6 | 0.30   | 7.7 |
| Pre-Mate 9.3mm                | 0.83  | 21.2 | 0.37   | 9.3 |
| Post-Mate 6.4mm               | 0.72  | 18.3 | 0.25   | 6.4 |

## Socket Contacts for 1x4 Auxiliary Connector

Selectively gold plated contacts offer low resistance and durability up to 10,000 mating cycles.

| Description      | AWG      | mm <sup>2</sup> | ----- Part Numbers ----- |                 |
|------------------|----------|-----------------|--------------------------|-----------------|
| Minimum Quantity |          |                 | 500                      | 50              |
| Socket Contact   | 12       | 2.5             | PM16S12S32               | PM16S12S32-50   |
|                  | 16 to 14 | 1.0 to 1.5      | PM16S1416S32             | PM16S1416S32-50 |
|                  | 20 to 16 | 0.75 to 1.0     | PM16S1620S32             | PM16S1620S32-50 |
|                  | 24 to 20 | 0.50 to 0.75    | PM16S2024S32             | PM16S2024S32-50 |

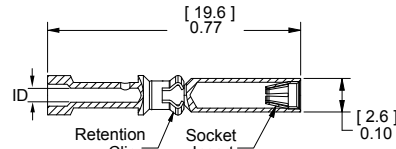

**Auxiliary Socket Contacts  
Crimp Barrel ID**

| Wire Gauge | in.  | mm. |
|------------|------|-----|
| #24 / 20   | 0.04 | 1.1 |
| #20 / 16   | 0.07 | 1.7 |
| #16 / 14   | 0.08 | 2.1 |
| #12        | 0.10 | 2.6 |

## SBE® Air Tubes

Air tubes fit into SBE® housings to allow electrolyte circulation while charging the battery. Genderless tube design allows the same part to be used on both sides. (2) Retaining pins or (1) Retaining clip is required to hold the air tube in place. Retaining pins are included in Air Tube Kit.

| Description         | ---- Part Numbers ---- |        |
|---------------------|------------------------|--------|
| Minimum Quantity    | 500                    | 25     |
| Air Tube Kit, Black | -                      | 6396G1 |
| Air Tube Only       | 3-5798P1               | -      |

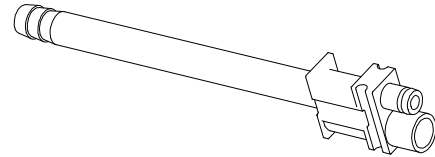

## PPMX Auxiliary Connector

The PPMX auxiliary connector allows up to 8 auxiliary circuits to be used in the SBE®, SBO®, & SBX® housings. There are 4 auxiliary circuits per PPMX connector and two PPMX housings fit into the auxiliary port in the main connector housing. Rated up to 7 amps 300 volts per contact, the genderless design holds two each gold plated pin & socket contacts. This innovation allows the very durable and cost effective design of SBE®, O, X connectors to be used for applications requiring up to 8 battery monitoring or equipment vehicle communication circuits. (2) Retaining pins or (1) Retaining clip is required to hold the auxiliary housing in place.

Auxiliary Kits includes: (1) Auxiliary Housing, (2) Pin Contacts, and (2) Socket Contacts.

| Description           | AWG                      | mm <sup>2</sup> | ----- Part Numbers ----- |        |        |
|-----------------------|--------------------------|-----------------|--------------------------|--------|--------|
| Minimum Quantity      |                          |                 | 1,000                    | 100    | 25     |
| PPMX Auxiliary Kit    | 24 to 20                 | 0.50 to 0.25    | -                        | 4850G6 | -      |
| 1x4 Auxiliary Housing | Contacts Sold Separately |                 | 4827G6-BK                | -      | 4827G6 |

\* No extraction tool required for contact removal.

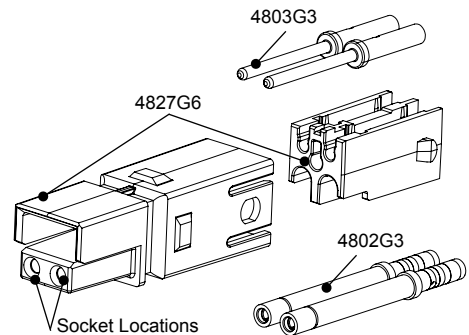

## Pin & Socket Contacts for PPMX Auxiliary Connector

Gold plated contacts are ideal for signal or low power use with durability up to 5,000 mating cycles.

| Description      | AWG      | mm <sup>2</sup> | ----- Part Numbers ----- |        |
|------------------|----------|-----------------|--------------------------|--------|
| Minimum Quantity |          |                 | 2,000                    | 50     |
| Pin Contacts     | 24 to 20 | 0.50 to 0.25    | 4803G3-BK                | 4803G3 |
| Socket Contacts  | 24 to 20 | 0.50 to 0.25    | 4802G3-BK                | 4802G3 |

## Retaining Clip

Retaining clips can be used in place of two retaining pins to hold auxiliary connectors or air tubes. Allows easier removal of auxiliary modules.

| Description           | -- Part Number -- |
|-----------------------|-------------------|
| Minimum Quantity      | 100               |
| For SBE®320 & SBX®350 | 2-8675P1          |

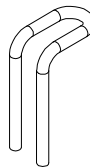

## Retaining Pins

Retaining pins are used to hold accessories in the auxiliary port in SBE®, SBO®, & SBX® housings. Dimension "B" is +/- 0.015 in or 0.38 mm.

| Description           | - Part Number - | Dimensions    |             |        |       |
|-----------------------|-----------------|---------------|-------------|--------|-------|
|                       |                 | - A -         |             | - B -  |       |
|                       |                 | inches        | mm          | inches | mm    |
| Minimum Quantity      | 1,000           |               |             |        |       |
| For SBE®320 & SBX®350 | 110G59-BK       | 0.093 / 0.103 | 2.36 / 2.62 | 1.000  | 25.40 |

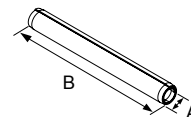

### Zip Cable Straps

Zip cable straps are used to secure auxiliary wires to the side of the main power cables.

| Description         | --- Part Number --- |
|---------------------|---------------------|
| Minimum Quantity... | 1,000 .....         |
| White               | H1835P3             |

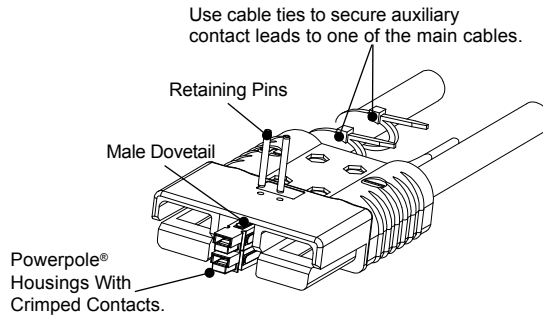

### Manual Release - Battery Side

Works with the Charger / Truck side to ease mating and unmating connectors.

| Description              | --- Part Numbers --- |
|--------------------------|----------------------|
| Minimum Quantity .....   | 72 25 ....           |
| Bracket and Hardware Kit | - 993G1              |
| Battery Bracket Only     | 111961P1 -           |
| Hardware Bag             | - 106G6              |

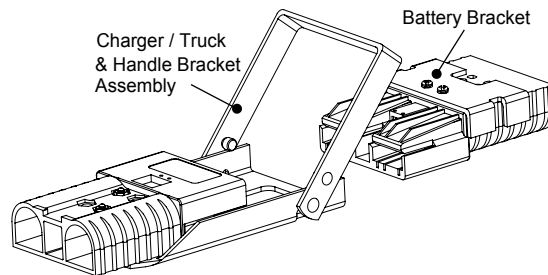

### Manual Release - Charger/ Truck Side

Works with the Battery side to ease mating and unmating connectors.

| Description              | - Part Numbers - |
|--------------------------|------------------|
| Minimum Quantity .....   | 25 .....         |
| Bracket and Hardware Kit | 994G1            |
| Bracket / Lever Only     | B00511G4         |
| Hardware Bag             | 106G6            |

### Reducing Bushings: for Use with Contact # 6354 and Bushing # 5918

Use with contact part number 6354-BK and bushing part number 5918-BK to allow a smaller wire to be used with the connector. Electrical capability is derated with smaller wire.

| Bushings # 5918 Barrel Size Wire Size          | Part Numbers |         |         |      | Dimensions - ID - |      |
|--|--------------|---------|---------|------|-------------------|------|
|  | 1,500        | 1,000   | 500     | 100  | inches            | mm   |
| Minimum Quantity .....                         | 1,500        | 1,000   | 500     | 100  |                   |      |
| 1/0 AWG [53.5 mm²] #1 AWG [42.4 mm²]           | -            | -       | 5687-BK | 5687 | 0.39              | 9.91 |
| 1/0 AWG [53.5 mm²] #2 AWG [33.6 mm²]           | 5690-BK      | -       | -       | 5690 | 0.34              | 8.64 |
| 1/0 AWG [53.5 mm²] #4 AWG [21.2 mm²]           | -            | 5693-BK | -       | 5693 | 0.27              | 6.86 |
| 1/0 AWG [53.5 mm²] #6 AWG [13.3 mm²]           | -            | 5663-BK | -       | 5663 | 0.22              | 5.59 |
| 1/0 AWG [53.5 mm²] #10 - 8 AWG [5.3 - 8.4 mm²] | 5648-BK      | -       | -       | 5648 | 0.19              | 4.83 |

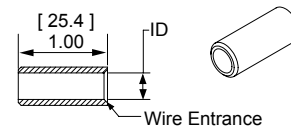

### Reducing Bushings: for Use with Contact # 6354

Use with contact part number 6354-BK to allow a smaller wire to be used with the connector. Electrical capability is derated with smaller wire.

| Contact Barrel Size Wire Size         | --- Part Number --- |
|---------------------------------------|---------------------|
| Minimum Quantity .....                | 500 100 ...         |
| 2/0 AWG [67.4 mm²] 1/0 AWG [53.5 mm²] | 5918-BK 5918        |

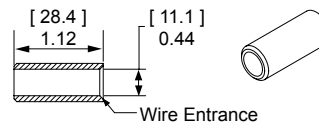

### Reducing Bushings: for Use with Contact # 6394

Use with contact part number 6394-BK to allow a smaller wire to be used with the connector. Electrical capability is derated with smaller wire.

| Contact Barrel Size Wire Size | -- Part Numbers -- | Dimensions - ID - |     |
|-------------------------------|--------------------|-------------------|-----|
|                               |                    | inches            | mm  |
| Minimum Quantity .....        | 1,000 100 .....    |                   |     |
| 35 mm² 16 mm²                 | 5920-BK 5920       | 0.23              | 5.8 |

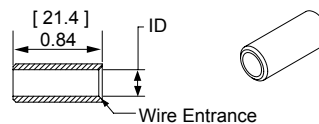

# SBO® / SBE® / SBX® - Tooling Information

| Wire Size                                     |                    | Loose Piece Part Numbers<br>Contacts | Loose Piece Contact Crimp Tool |         |         |                  |                  |
|---|--------------------|--------------------------------------|--------------------------------|---------|---------|------------------|------------------|
| AWG   | mm <sup>2</sup>    |                                      | Pneumatic Bench Tool           | Die     | Locator | Number of Crimps | or Hand Tool     |
| <b>SBE® 320 / SBX® 350</b>                    |                    |                                      |                                |         |         |                  |                  |
| 300 MCM                                       | 152                | 6358                                 | N/A                            | N/A     | N/A     | N/A              | 1368 Series      |
| 4/0 AWG                                       | 107.2              | 6356                                 | 1387G2                         | 1303G12 | 1304G28 | Double           |                  |
| 3/0 AWG                                       | 85                 | 6355                                 |                                |         |         |                  |                  |
| 2/0 AWG                                       | 67.4               | 6354                                 |                                |         |         |                  |                  |
| #2  | N/A                | 6394                                 |                                |         |         |                  |                  |
| N/A   | 95 mm <sup>2</sup> | 1341G3                               | 1387G2                         | 1303G17 | 1304G35 | Double           |                  |
| N/A   | 70 mm <sup>2</sup> | 1341G2                               |                                |         |         |                  |                  |
| N/A   | 50 mm <sup>2</sup> | 1341G1                               |                                |         |         |                  |                  |
|   |                    |                                      |                                |         |         |                  |                  |
| <b>SBE® 160 / SBX® 175</b>                    |                    |                                      |                                |         |         |                  |                  |
| 1/0 AWG                                       | 53.5               | 6384G1                               | 1387G2                         | 1303G2  | 1304G13 | Single           | 1368 Series      |
| #2  | 35 mm <sup>2</sup> | 6384G2                               | 1387G1                         | 1388G3  | 1389G3  |                  |                  |
|   |                    |                                      | 1387G2                         | 1303G2  | 1304G13 |                  |                  |
| <b>SBO® 60 / SBE® 80</b>                      |                    |                                      |                                |         |         |                  |                  |
| #4  | 25                 | 1339G4                               | 1387G1                         | 1388G7  | 1389G9  | Single           | N/A              |
| #6  | 16                 | 1339G1                               |                                | 1388G6  |         |                  | 1309G4           |
| <b>Powerpole® 15/45 Auxiliary Contacts **</b> |                    |                                      |                                |         |         |                  |                  |
| #16 / 20                                      | 1.3 / .52          | 1332                                 | N/A                            | N/A     | N/A     | Single           | 1309G2 or 1309G8 |
| #12 / 16                                      | 3.3 / 1.3          | 1331                                 |                                |         |         |                  |                  |
| <b>PowerMod® 1x4 Auxiliary Contacts</b>       |                    |                                      |                                |         |         |                  |                  |
| #12 / 24                                      | 2.5 / .25          | All Crimp Pins                       | TP0001*                        | N/A     | TL0001  | Single           | TM0001*          |
|   |                    | All Crimp Sockets                    |                                |         | TL0002  |                  | PM1000G1         |
| <b>PPMX Auxiliary Contacts</b>                |                    |                                      |                                |         |         |                  |                  |
| #20 / 24                                      | 0.50 / 0.25        | 4803G3                               | TP0001*                        | N/A     | TL0005  | Single           | TM0001* or       |
|   |                    | 4802G3                               |                                |         |         |                  | PM1000G1         |

\* TP0001 and TM0001 tools require locators to properly position contacts.

\*\* See Powerpole® family tooling chart for other Powerpole® contacts

SBE®160 / SBX®175 Power Contact Extraction Tool: 969P1

SBE®320 / SBX®350 Power Contact Extraction Tool: 970P1

1 x 4 Auxiliary contact Insertion Tool: PM1002G1

1 x 4 Auxiliary Contact Extraction Tool: PM1003G1

The auxiliary contacts used with wire sizes #16 - #24 AWG cannot be properly inserted without the insertion tool. Properly installed auxiliary contact of all wire gauges cannot be removed from the housing without the extraction tool.